ELIT-1060

Digital Signage Player Powered by
Intel® Celeron® N6210 Processor

User's Manual

Version 1.0

Revision History

Version	Date	Description
1.0	2023.03	Initial release

Revision History	ii
Contents	i
Preface.....	iii
Copyright Notice	iii
Declaration of Conformity	iii
CE.....	iii
FCC Class A	iii
RoHS	iv
SVHC / REACH	iv
Important Safety Instructions	v
Warning.....	vi
Lithium Battery Replacement.....	vi
Technical Support	vi
Warranty.....	vii
Chapter 1 - Introduction.....	1
1.1. Features.....	2
1.2. About this Manual	2
1.3. Specifications.....	3
1.4. Inside the Package	4
1.5. Ordering Information	5
1.5.1. Configure-to-Order Service.....	5
Chapter 2 - Getting Started.....	7
2.1. Dimensions	8
2.2. Overview	9
2.3. Driver Installation Note.....	10
Chapter 3 - Engine of the Computer.....	11
3.1. Board Layout.....	12
3.1.1. Internal Diagram-Top Side:	12
3.1.2. Internal Diagram-Bottom Side:	13
3.1.3. Connectors	13
3.1.4. Headers	14
3.1.5. Jumper.....	14
3.1.6. Jumper Setting.....	15
3.1.7. Pin Definition.....	17
3.1.8. Maximum Voltage & Current Limit	20
Chapter 4 - Installation and Maintenance.....	21
4.1. Access the Inside of the Computer	22
4.1.1. Disassemble the Computer	22
4.1.2. Reassemble the Computer	24

4.2. Install Hardware	24
4.2.1. Install M.2 M-key Storage	24
4.2.2. Install Wi-Fi Module	26
4.2.3. Install Memory Module.....	30
4.3 Mount the Computer	32
4.3.1 ELIT-1060 Wall Mounting	32
4.3.2 ELIT-1060 DIN Rail Mounting.....	33
Chapter 5 - BIOS	35
5.1. Main	38
5.2. Advanced	39
5.2.1. CPU Configuration.....	40
5.2.2. Intel(R) Time Coordinated Computing	42
5.2.3. Trusted Computing	43
5.2.4. ACPI Settings.....	44
5.2.5. Super IO Configuration	45
5.2.6 Serial Port Console Redirection.....	47
5.2.7. PC Health Status	49
5.2.8. USB Configuration	50
5.2.9. Network Stack Configuration	52
5.2.10. NVMe Configuration	53
5.2.11. Wake-up Function Settings.....	54
5.2.12. PTT Configuration.....	56
5.3. Chipset.....	57
5.3.1. System Agent (SA) Configuration	58
5.3.2. PCH-IO Configuration.....	59
5.4. Security	61
5.5. Boot.....	63
5.6. Save & Exit	64

Copyright Notice

All Rights Reserved.

The information in this document is subject to change without prior notice in order to improve the reliability, design and function. It does not represent a commitment on the part of the manufacturer.

Under no circumstances will the manufacturer be liable for any direct, indirect, special, incidental, or consequential damages arising from the use or inability to use the product or documentation, even if advised of the possibility of such damages.

This document contains proprietary information protected by copyright. All rights are reserved. No part of this document may be reproduced by any mechanical, electronic, or other means in any form without prior written permission of the manufacturer.

Declaration of Conformity

CE

The CE symbol on your product indicates that it is in compliance with the directives of the Union European (EU). A Certificate of Compliance is available by contacting Technical Support.

This product has passed the CE test for environmental specifications when shielded cables are used for external wiring. We recommend the use of shielded cables. This kind of cable is available from ARBOR. Please contact your local supplier for ordering information.

Warning

This is a class B product. In a domestic environment this product may cause radio interference in which case the user may be required to take adequate measures.

FCC Class A

This device complies with Part 15 of the FCC Rules. Operation is subject to the following two conditions:

- (1) This device may not cause harmful interference, and
- (2) This device must accept any interference received, including interference that may cause undesired operation.

NOTE:

This equipment has been tested and found to comply with the limits for a Class A digital device, pursuant to Part 15 of the FCC Rules. These limits are designed to provide reasonable protection against harmful interference when the equipment is operated in a commercial environment. This equipment generates, uses, and can radiate radio frequency energy and, if not installed and used in accordance with the instruction manual, may cause harmful interference to radio communications. Operation of this equipment in a residential area is likely to cause harmful interference in which case the user will be required to correct the interference at his own expense.

RoHS

ARBOR Technology Corp. certifies that all components in its products are in compliance and conform to the European Union's Restriction of Use of Hazardous Substances in Electrical and Electronic Equipment (RoHS) Directive 2002/95/EC.

The above mentioned directive was published on 2/13/2003. The main purpose of the directive is to prohibit the use of lead, mercury, cadmium, hexavalent chromium, polybrominated biphenyls (PBB), and polybrominated diphenyl ethers (PBDE) in electrical and electronic products. Member states of the EU are to enforce by 7/1/2006.

ARBOR Technology Corp. hereby states that the listed products do not contain unintentional additions of lead, mercury, hex chrome, PBB or PBDB that exceed a maximum concentration value of 0.1% by weight or for cadmium exceed 0.01% by weight, per homogenous material. Homogenous material is defined as a substance or mixture of substances with uniform composition (such as solders, resins, plating, etc.). Lead-free solder is used for all terminations (Sn(96-96.5%), Ag(3.0-3.5%) and Cu(0.5%)).

SVHC / REACH

To minimize the environmental impact and take more responsibility to the earth we live, Arbor hereby confirms all products comply with the restriction of SVHC (Substances of Very High Concern) in (EC) 1907/2006 (REACH --Registration, Evaluation, Authorization, and Restriction of Chemicals) regulated by the European Union.

All substances listed in SVHC < 0.1 % by weight (1000 ppm)

Important Safety Instructions

Read these safety instructions carefully

1. Read all cautions and warnings on the equipment.
2. Place this equipment on a reliable surface when installing. Dropping it or letting it fall may cause damage
3. Make sure the correct voltage is connected to the equipment.
4. For pluggable equipment, the socket outlet should be near the equipment and should be easily accessible.
5. Keep this equipment away from humidity.
6. The openings on the enclosure are for air convection and protect the equipment from overheating. **DO NOT COVER THE OPENINGS.**
7. Position the power cord so that people cannot step on it. Do not place anything over the power cord.
8. Never pour any liquid into opening. This may cause fire or electrical shock.
9. Never open the equipment. For safety reasons, the equipment should be opened only by qualified service personnel.
10. If one of the following situations arises, get the equipment checked by service personnel:
 - a. The power cord or plug is damaged.
 - b. Liquid has penetrated into the equipment.
 - c. The equipment has been exposed to moisture.
 - d. The equipment does not work well, or you cannot get it to work according to the user's manual.
 - e. The equipment has been dropped or damaged.
 - f. The equipment has obvious signs of breakage.
11. Keep this User's Manual for later reference.

Warning

The Box PC and its components contain very delicately Integrated Circuits (IC). To protect the Box PC and its components against damage caused by static electricity, you should always follow the precautions below when handling it:

1. Disconnect your Box PC from the power source when you want to work on the inside.
2. Use a grounded wrist strap when handling computer components.
3. Place components on a grounded antistatic pad or on the bag that came with the Box PC, whenever components are separated from the system.

Lithium Battery Replacement

Incorrect replacement of the lithium battery may lead to a risk of explosion.

The lithium battery must be replaced with an identical battery or a battery type recommended by the manufacturer.

Do not throw lithium batteries into the trash can. It must be disposed of in accordance with local regulations concerning special waste.

Technical Support

If you have any technical difficulties, please consult the user's manual first at:
<http://www.arbor-technology.com>

Please do not hesitate to call or e-mail our customer service when you still cannot find out the answer.

<http://www.arbor-technology.com>

E-mail:info@arbor.com.tw

Warranty

This product is warranted to be in good working order for a period of one year from the date of purchase. Should this product fail to be in good working order at any time during this period, we will, at our option, replace or repair it at no additional charge except as set forth in the following terms. This warranty does not apply to products damaged by misuse, modifications, accident or disaster.

Vendor assumes no liability for any damages, lost profits, lost savings or any other incidental or consequential damage resulting from the use, misuse of, or inability to use this product. Vendor will not be liable for any claim made by any other related party.

Vendors disclaim all other warranties, either expressed or implied, including but not limited to implied warranties of merchantability and fitness for a particular purpose, with respect to the hardware, the accompanying product's manual(s) and written materials, and any accompanying hardware. This limited warranty gives you specific legal rights.

Return authorization must be obtained from the vendor before returned merchandise will be accepted. Authorization can be obtained by calling or faxing the vendor and requesting a Return Merchandise Authorization (RMA) number. Returned goods should always be accompanied by a clear problem description.

This page is intentionally left blank.

Chapter 1

Introduction

1.1. Features

- Fanless and Ultra Compact Design
- Intel® Celeron® N6210 (1.5M Cache, up to 2.60 GHz)
- Support Triple Display: 2 x HDMI, 1 x DisplayPort
- Onboard 32GB eMMC
- Dual 2.5Gb ethernet & Support TPM 2.0
- 1 x COM, 2 x USB3.2 (Gen.2), 1 x USB2.0, 2 x USB Type-C
- 1 x M.2 M-key, (2260/2280), 1 x M.2 E-key (2230)
- Supports Windows® 10 / Windows® 11



1.2. About this Manual

This manual is meant for the experienced users and integrators with hardware knowledge of personal computers. If you are not sure about the description in this manual, consult your vendor before further handling.

We recommend that you keep one copy of this manual for the quick reference for any necessary maintenance in the future. Thank you for choosing ARBOR products.

1.3. Specifications

System	
CPU	Soldered onboard Intel® Celeron® N6210, 1.20GHz
Memory	1 x 260 pin DDR4 SO-DIMM socket up to 32GB (4GB DDR4 SO-DIMM pre-installed)
LAN Chipset	2 x Intel® i225V controller
Chipset	SoC Integrated
Graphics	Intel® UHD Graphics for 10 th Gen Intel® Processors
ATA	1 x Serial ATA port with 600MB/s HDD transfer rate
Watchdog Timer	1~255 levels reset
TPM	Support TPM 2.0
Storage	
Type	Onboard 32GB eMMC 1 x M.2 M-key (2260/2280, PCIe Gen.3 x2/SATA interface) support NVMe
Audio	
Type	Line-out/ MIC-in combo
Button	
Button	Power on/off button
Power System	
Power Input	DC 12V input by lockable DC Jack
Power Consumption	Typical 24W (w/o I/O cards)
Qualification	
Certification	CE, FCC Class A
I/O	
Serial Port	1 x DB-9 connectors for RS232/422/485 (RI/5V/12V)
USB Ports	2 x Type-A USB 3.2 (Gen 2)
	1 x Type-A USB 2.0
	2 x Type-C USB 3.2 (Gen 2)
LAN	2 x RJ-45 ports for 2.5 GbE LAN
Video Ports	1 x DP (Max Resolution: 4096x2160@60Hz)
	2 x HDMI 2.0 (Max Resolution: 4096x2160@60Hz)
Expansion Bus	1 x M.2 E-key (2230, PCIe Gen.3 x1/ USB2.0 interface) for Wireless connective
Others	2 x Antenna holes

Mechanical	
Mounting Type	Desktop (default) Wall-mount and DIN-Rail mount (optional)
Chassis	Aluminum alloy
Dimensions (W x D x H)	118 x 108 x 49.5mm
Weight (Net)	0.66kg
Environmental	
Operating Temp.	-20 ~ 60°C
Storage Temp.	-20 ~ 60°C
Operating Humidity	10%-95% RH @ 60°C (non-condensing)
Vibration	3 Grms/5~500Hz/random operation
Shock	Operating 50G (11ms) with eMMC
OS Support	
Windows® 10 / Windows® 11	

1.4. Inside the Package

Upon opening the package, carefully inspect the contents. If any of the items is missing or appears damaged, contact your local dealer or distributor. The package should contain the following items:



1 x ELIT-1060



Standard Accessories contain the following items:







- 1 x DDR4 4GB SO-DIMM Memory (pre-installed)
- User's manual

1.5. Ordering Information

ELIT-1060	Ultra Compact Controller by Intel® Celeron N6210 w/32GB eMMC
-----------	--

1.5.1. Configure-to-Order Service

Make the computer more tailored to your needs by selecting one or more components from the list below to be fabricated to the computer.

P A C - 6 0 W 1 A - FSP-ES	AC/DC ADAPTER KIT, 12V, 60W, 2.5 DC JACK LOCKABLE w/ EU & USA POWER CORD	
MM-4C-8G/16G	DDR4-2400 8GB/16GB SO-DIMM MEMORY	
64GB M.2 SSD	M.2 M-key 2280, 64GB, SATA3.0	
WiFi-AT3550	Atheros QCNFA364A M.2 WiFi module w/ 2*30cm internal wiring	
ANT-D11	1 x Wi-Fi Dual-band 2.4G/5G antenna	
DRK-1060	ELIT-1060 DIN Rail Kitt	
WMK-1060	Wall Mount Kit For ELIT-1060	

This page is intentionally left blank.

Chapter 2

Getting Started

2.1. Dimensions

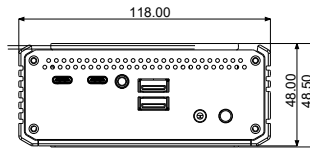
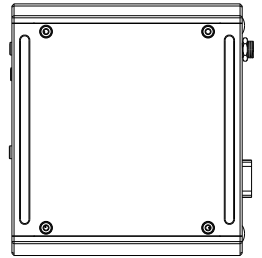
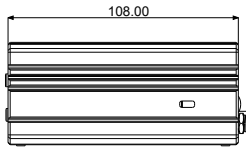
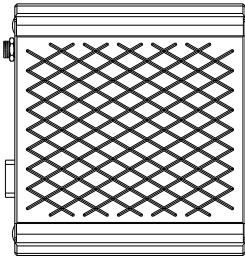
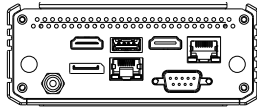

Unit: mm

2.2. Overview

Take a look around the computer and find the external controls and connectors.

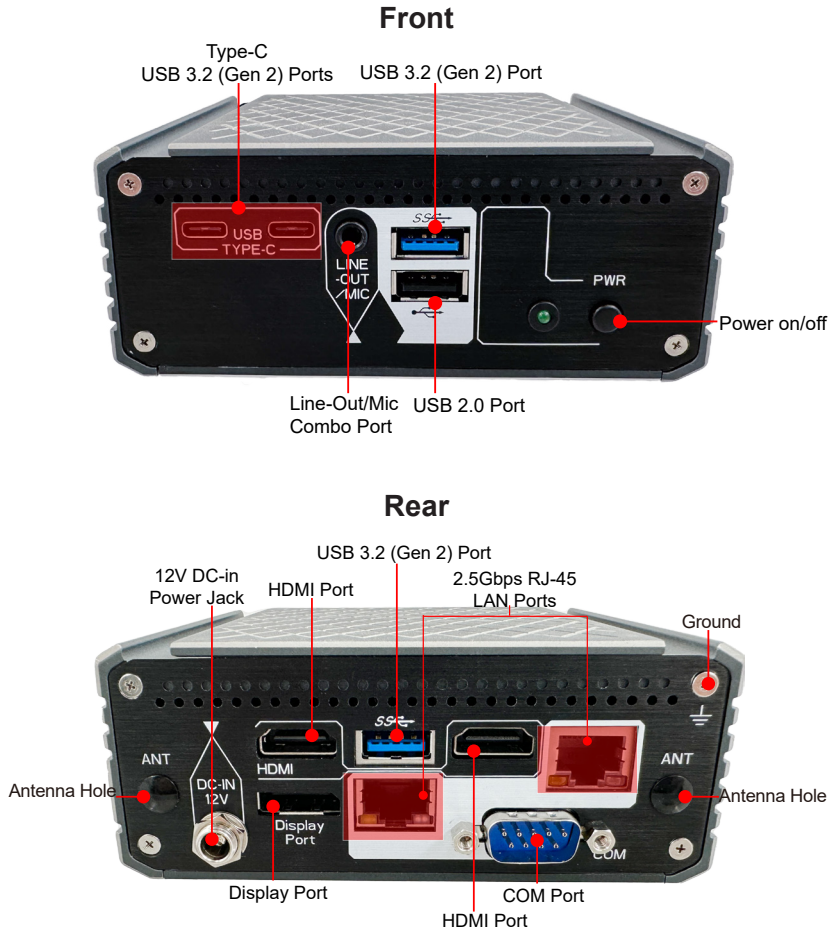

2.3. Driver Installation Note

To install the drivers, please visit our website at **www.arbor-technology.com** and download the driver pack from the product page. If you need login access, please contact your local ARBOR sales representative.

Device	Driver Path
Audio	\\audio_eh\Setup.exe
Ethernet	\\intellan_eh\Autorun.exe
Graphic	\\gfx_eh\Installer.exe
ME	\\ime_eh\SetupME.exe
Chipset	\\inf_eh\SetupChipset.exe

Chapter 3

Engine of the Computer

3.1. Board Layout

3.1.1. Internal Diagram-Top Side:

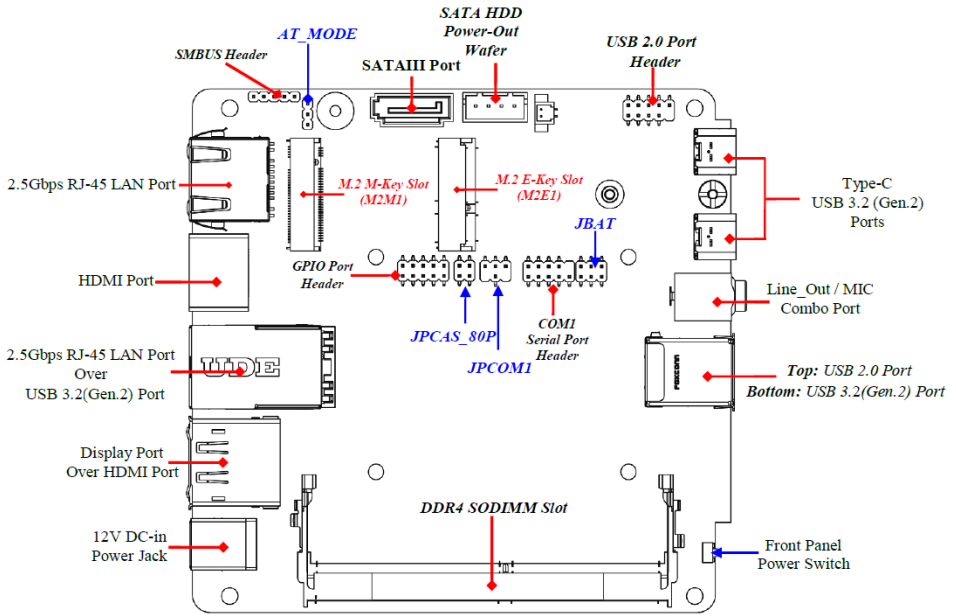

3.1.2. Internal Diagram-Bottom Side:

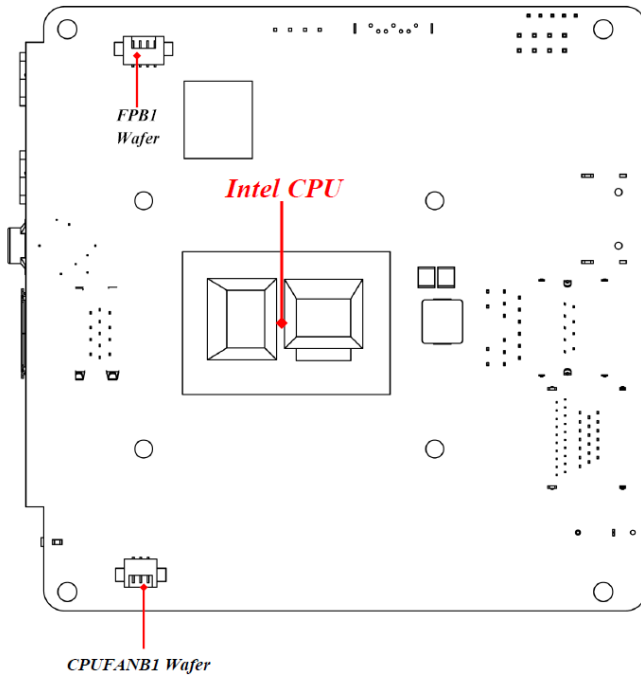

3.1.3. Connectors

Connector	Name
DCIN1	12V DC-in System Power Jack
DP1_HDMI2	Top: Display Port Connector Bottom: HDMI Connector
UL2	Top: 2.5Gbps RJ-45 LAN Port Connector Bottom: USB 3.2(Gen.2) Port Connector
HDMI1	HDMI Connector
LAN1	2.5Gbps RJ-45 LAN Port Connector
USB31	Top: USB 2.0 Port Connector Bottom: USB 3.2(Gen.2) Port Connector
AUDIO1	Line-Out/MIC Combo Connector
USBC1/USBC2	USB 3.2(Gen.2) Type-C Port Connector
SATA1	SATAIII Port Connector
SATAPWR	SATA HDD Power out Wafer
FPB1 (backside)	Front Panel Power Wafer
CPUFANB1(backside)	CPUFAN Wafer

3.1.4. Headers

Header	Name	Description	Pitch
SMBUS	SMBUS Header	5-pin Block	2.0mm
FP_USB21	USB 2.0 Port Header	9-pin Block	2.0mm
COM1	Serial Port Header	9-pin Block	2.0mm
GPIO	GPIO Header	10-pin Block	2.0mm

3.1.5. Jumper

Header	Name	Description	Pitch
AT_MODE	ATX Mode/ AT Mode Select	3-pin Block	2.0mm
JPCAS_80P	Pin (1-2): Case Open Display Select Pin (3-4): GPIO/80 Port Function Select	4-pin Block	2.0mm
JPCOM1	COM1 Port Pin9 Function Select	4-pin Block	2.0mm
JBAT	Pin (1-2): Clear RTC Pin (3-4): Clear CMOS Pin (5-6): ME Disabled	6-pin Block	2.0mm

3.1.6. Jumper Setting

AT_MODE (2-pin): ATX Mode & AT Mode Select (Pitch:2.0mm)

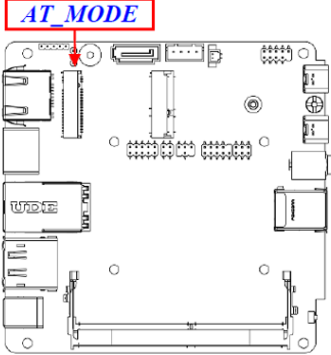

AT_MODE → ATX/AT Mode Select



1-2 Closed: ATX Mode;



2-3 Closed: AT Mode.

- **ATX Mode Selected:** Press power button to power on after power input ready;
- **AT Mode Selected:** Directly power on as power input ready. User needs to restart the system for the settings to take effect.

Pin 1&2 of JPCAS_80P (4-pin): Case Open Display Select (Pitch 2.0mm)

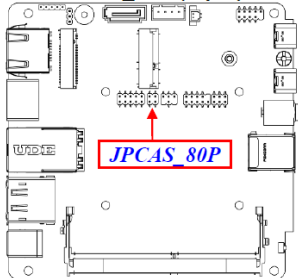

Pin 1&2 of JPCAS_80P
→ Case Open Detection

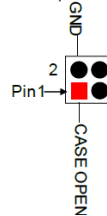

Pin (1&2) short: When Case open function pin short to GND, the Case open function was detected. When used, needs to enter BIOS and enable 'Case Open Detect' function. In this case if your case is removed, next time when you restart your computer, a message will be displayed on screen to inform you of this.

Pin 3&4 of JPCAS_80P (4-pin): GPIO Header GPIO/80 Port Select (Pitch 2.0mm)

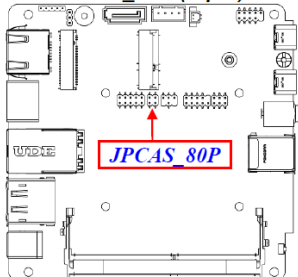

Pin 3&4 of JPCAS_80P
→ GPIO/80 Port Select



3-4 Open: GPIO = GPIO Port (default);



3-4 Closed: GPIO=80 Port.

JPCOM1 (4-pin): COM1 Port Pin9 Function Select (Pitch:2.0mm)

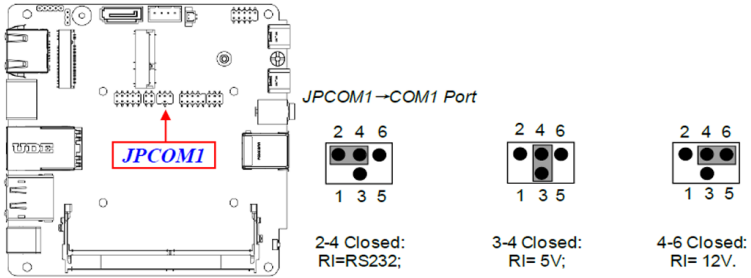

Pin 1&2 of JBAT (6-pin): Clear RTC (Pitch:2.0mm)

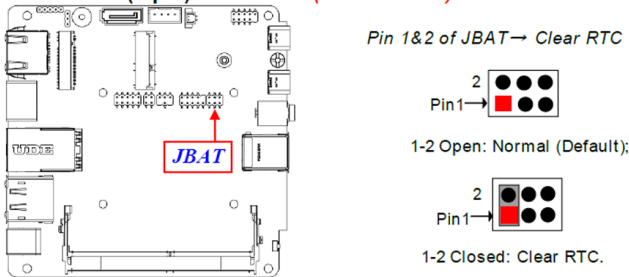

Pin (3&4) of JBAT (6-pin): Clear CMOS RAM Settings (Pitch:2.0mm)

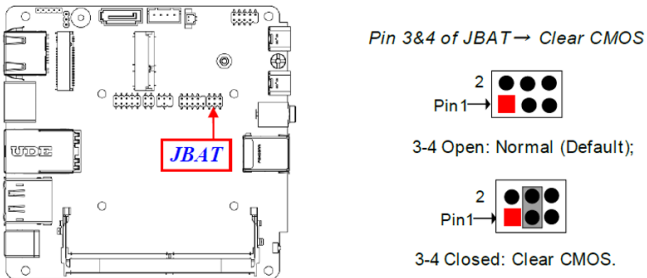

Pin 5&6 of JBAT (6-pin): ME Disabled (Pitch:2.0mm)

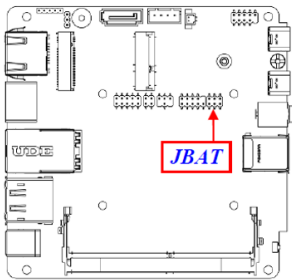

Pin 5&6 of JBAT → ME Disabled

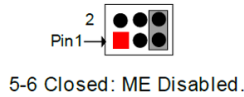
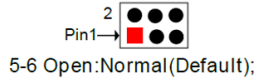

3.1.7. Pin Definition

For 2.5Gbps RJ-45 LAN port:

Speed LED Activity/Link LED

Speed LED

Status	Description
Off	10Mbps connection
Orange	1000Mbps connection
Green	2.5Gbps connection

Activity/Link LED

Status	Description
Off	No Link
Blinking	Data Activity
On	Link

*** Note: 2.5Gbps high-speed transmission rate is only supported over CAT 5e UTP cable.**

SATA1 (7-pin Block): SATAIII Port connector

The board comes with a SATAIII port that supports 6GB/s transfer rate.

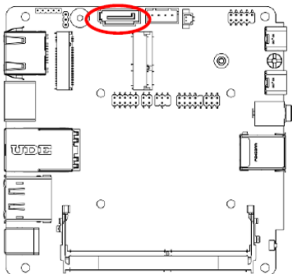

Pin No.	Definition
1	GND
2	TXP
3	TXN
4	GND
5	RXN
6	RXP
7	GND



SATAPWR (4-pin): SATA HDD Power-Out Wafer (Pitch:2.5mm)

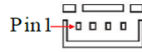
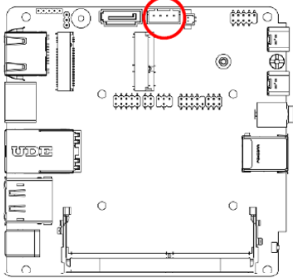

Pin No.	Definition
1	+5V
2	GND
3	GND
4	+12V

FPB1 (4-pin): Front Panel Wafer (Pitch:1.25mm)

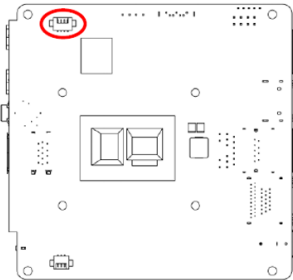

(Backside)

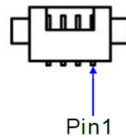

Pin No.	Definition
1	Power_SW
2	GND
3	PWRLED -
4	PWRLED+

CPUFANB1 (3-pin): CPUFAN Wafer (Pitch:1.25mm)

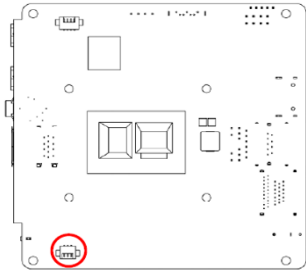

(Backside)



Pin No.	Definition
1	+5V
2	GND
3	Fan Detect

SMBUS (5-Pin): SM BUS Header (Pitch:2.0mm)

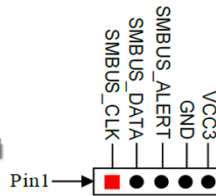
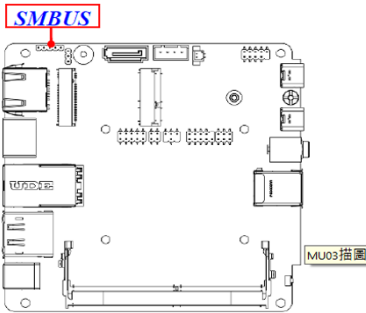

FP_USB21 (9-pin): USB 2.0 Port Header (Pitch:2.0mm)

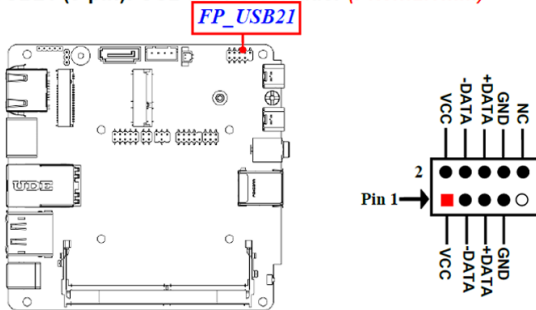

COM1 (9-pin Block): RS232/422/485 Serial Port Header (Pitch:2.0mm)

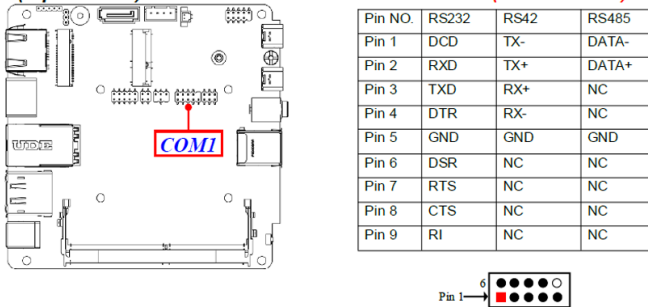

COM1 port can function as RS232/422/485 port. In normal settings COM1 functions as RS232 port. With compatible COM cable they can function as RS422 or RS 485 port. User also needs to go to BIOS to set '**Transmission Mode Select**' for COM1 (refer to **Page-43**) at first, before using specialized cable to connect different pins of this port.

3.1.8. Maximum Voltage & Current Limit

Below is a list of maximum voltage & Current Limit specification for motherboard interface (including but not limited to slots, connectors, wafers and headers) for setup reference:

Location	Function	Working Voltage	Current Support
USB31	USB3.2 x2	5V	1.5A
FP_USB21	USB2.0 x2	5V	1.5A
USBC1	Type-C ALT	5V	3A
USBC2	Type-C ALT	5V	3A
GPIO	GPIO/80 Port	5V	1A
CPUFANB1	CPU FAN	5V	0.5A
SATAPW1	SATA 4Pin Power	5V	1A
SMBUS	SMBUS	5V	0.3A

Chapter 4

Installation & Maintenance

4.1. Access the Inside of the Computer

To use onboard jumpers/connectors or to install/remove internal components, you will need to open the computer to access the inside of the computer. Follow through the guide below to access the inside of the computer.

4.1.1. Disassemble the Computer

1. Remove the 4 screws at the bottom side of the chassis



2. Lift the bottom case first, then you can see the internal main board.



3. Then you are ready to access the components of the main board.



4.1.2. Reassemble the Computer

After you make required jumper settings and connections, follow through the guide below to reassemble the computer.

1. Position the top case in a slightly slanted position and attach the front side first. Then push down the rear end to restore the top case.
2. Fasten the 4 screws at the bottom side of the chassis.



4.2. Install Hardware

4.2.1. Install M.2 M-key Storage

The computer's M.2 M-key socket supports 2260/2280 installation simultaneously. You can install either module as required.

To install an M.2 M-key storage module to the computer:

1. Remove the bottom cover from the computer as described in [4.1.1. Disassemble the Computer](#) on page [22](#). Locate the socket for M.2 M-key slot as the picture below.

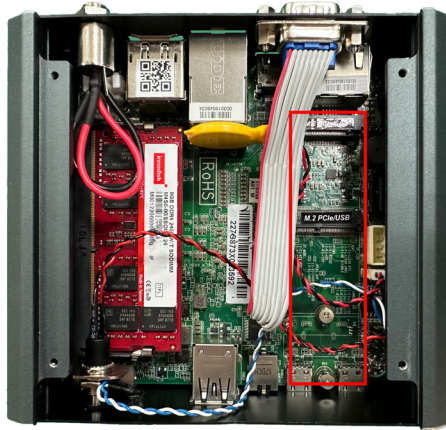

2. Insert the M.2 module into the socket by aligning the notch on the module with the small slot on the M.2 socket. By a slanted angle, fully insert the M.2 storage card until it cannot be inserted any more.

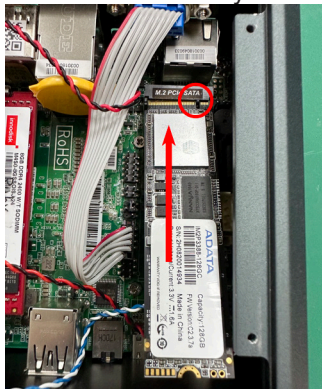

3. Press down the end of the M.2 PCIe storage and then fix the card in place using one screw.

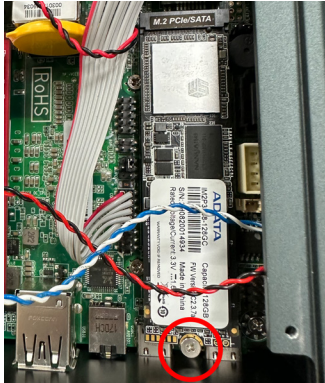

4.2.2. Install Wi-Fi Module

The computer comes with one half-size mini-PCIe socket to load the computer with a wireless module. This section will guide you to install the Wi-Fi module.

1. Remove the bottom cover from the computer as described in [4.1.1. Disassemble the Computer](#) on page [22](#). Locate the socket for M.2 E-key 2230 slot as the picture below.

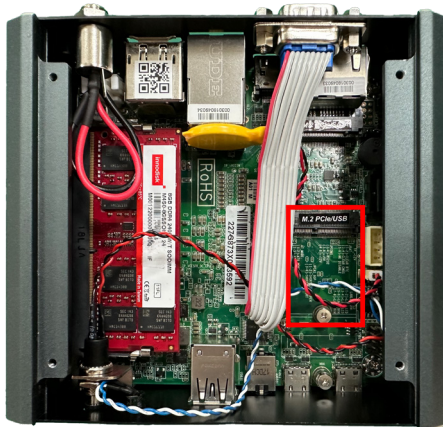

2. Prepare the Wi-Fi module kit. The module is a M.2 E-Key socket form factor, with two MHF connectors, one is "MAIN", and the other is "AUX".

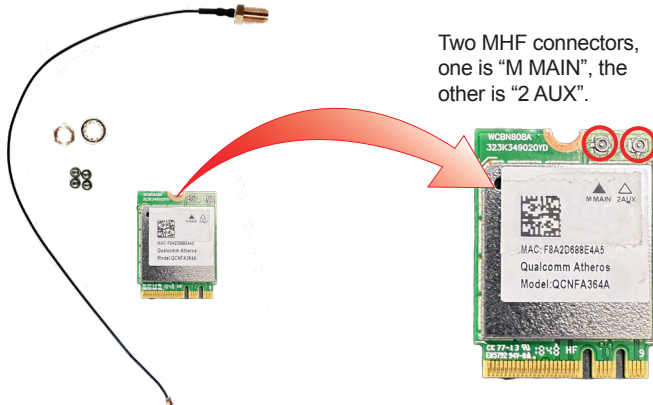

3. Have the RF antenna. The antenna has an SMA connector on one end and an MHF connector on the other.

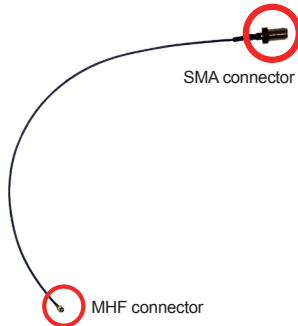

4. Connect the RF antenna's MHF connector to the Wi-Fi module's main connector marked M Main. If you are going to connect a secondary antenna, connect it to the connector marked 1 AUX.

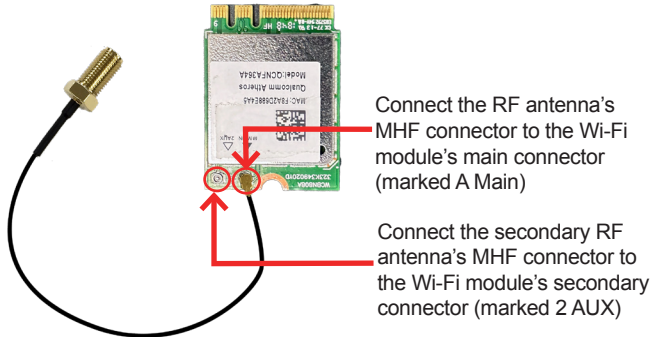

5. Plug the Wi-Fi module to the socket's connector by a slanted angle. Fully plug the module, and note the notch on the wireless module should meet the break of the connector.



6. Press the module down and fix the module in place using one screw.
7. Remove the plastic plug(s) from the computer's rear panel to make antenna hole(s). Keep the plastic plug for any possible restoration in the future.

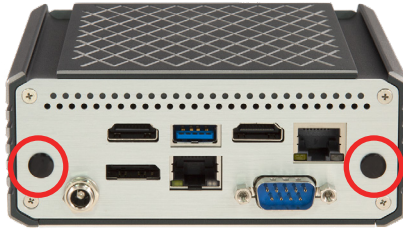

- From the other end of the RF antenna, which is an SMA connector, remove the washer and the nut. Save the washer and nut for later use. Note the SMA connector has the form of a threaded bolt, with one flat side.

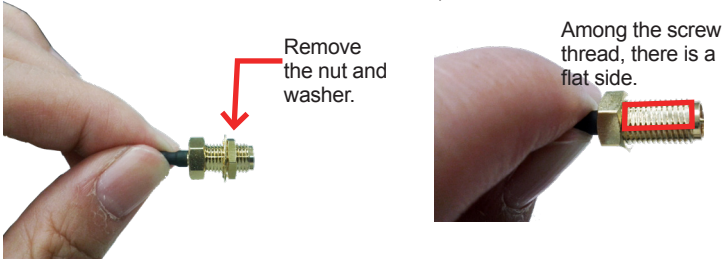

- Remove 4 screws of the back panel then pull the SMA connector through the above mentioned antenna hole. Note to meet the aforesaid flattened side with the antenna hole's flat side.

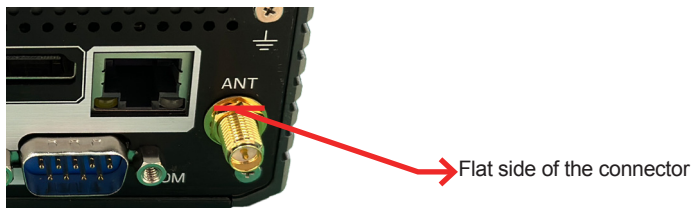
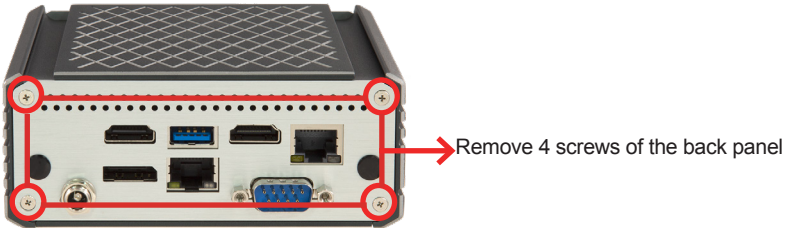

10. Reassemble the back panel after you make the required settings, mount the washer first and then the nut to the SMA connector. Make sure the nut is tightened.
11. Have the external antenna(s). Screw and tightly fasten the antenna(s) to the SMA connector(s).

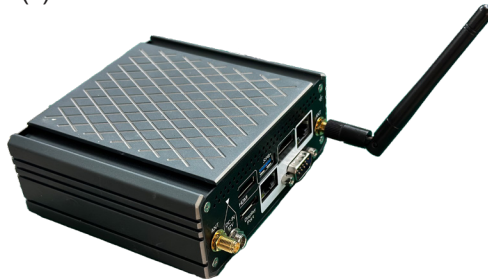

4.2.3. Install Memory Module

The main board has one dual inline memory module (DIMM) socket. Load the computer with a memory module to make the computer run programs. The memory module for the computer's SO-DIMM socket should be a 260-pin DDR4 with a "key notch" off the centre among the pins, which enables the memory module for particular applications. There are another two notches at each left and right side of the memory module to help fix the module in the socket.

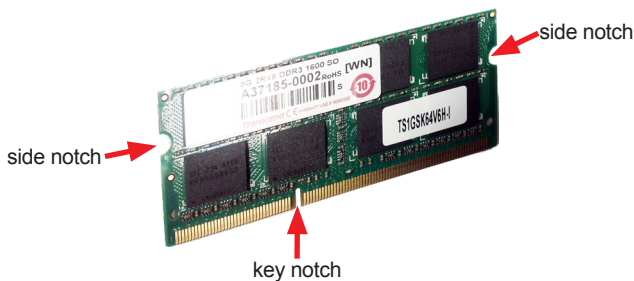

To install a memory module:

1. Locate the memory module socket beneath the main board.

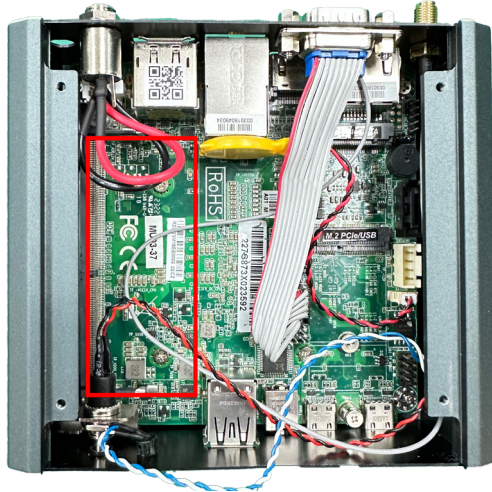

2. Adjust the socket polarizing key and the board key to the same direction. Insert the board obliquely. Moreover, lay the board in parallel to the opening at angle of 20° to 30°, and softly insert the board so as to hit the socket bottom. Stopping insertion halfway will result in improper insertion.
3. Applying the board side notch in parallel to the socket bottom so that the board position cannot be displaced, press the board side notch up, and fix it to the latch portion at both socket edges. Press the board side notch, and release the notch with a snap “click” tone, if the printed board exceeds the latch claw head.

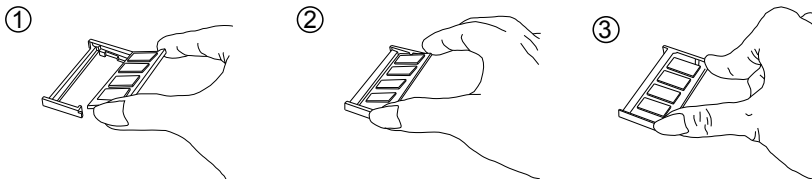

4. Procedures for board extraction. Apply the thumb nail to the latch knob at both socket edges. Forcibly widen the latch knobs to right and left ways, and release the latch. Then draw the board out along an angle where the board is raised.
5. Press down the memory module until it is auto-locked in place.

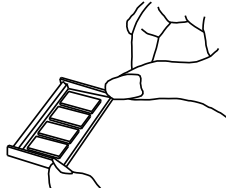

4.3 Mount the Computer

Install the PC to where it works by mounting it to a wall or DIN rail.

4.3.1 ELIT-1060 Wall Mounting

1. Have the computer brackets included in accessory pack. Put the provided wall-mounting kit into holes around edges then tightly fasten the wall mount around edges of the PC as the picture below.

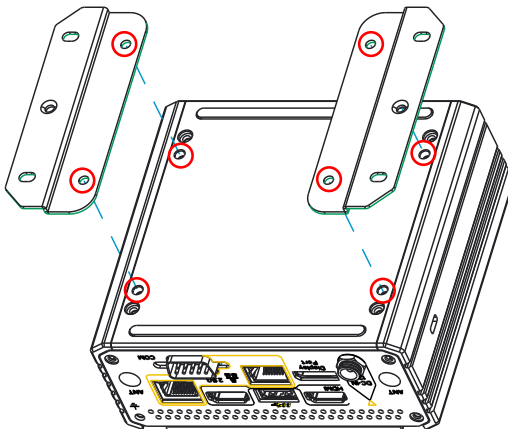

4.3.2 ELIT-1060 DIN Rail Mounting

1. Have the DIN rail brackets included in accessory pack. Put the provided DIN rail mounting kit into DIN rail slot on the PC.

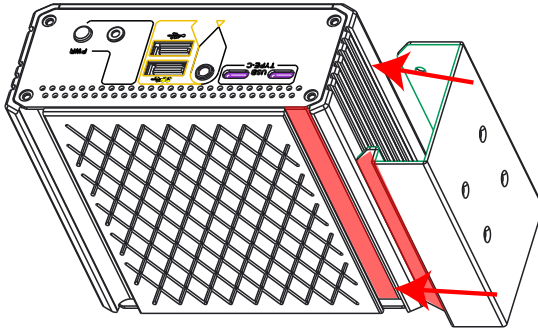

2. Then tightly fasten the DIN rail mount around edges of the PC as the picture below.

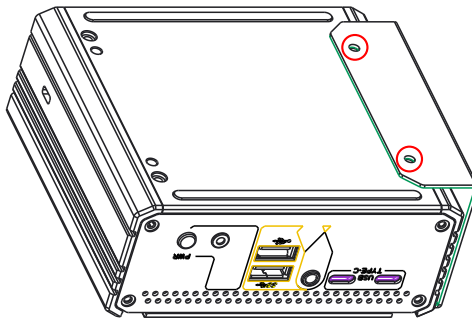

2. Then tightly fasten the DIN rail mount parts as the picture below.

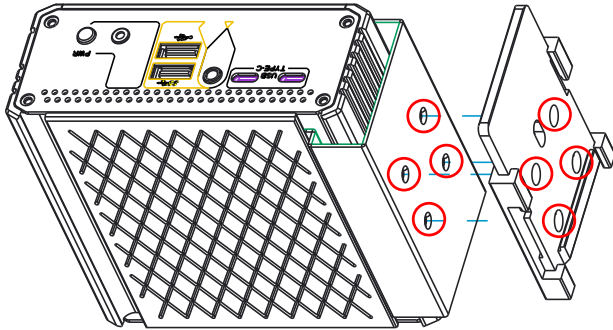

Chapter 5

BIOS

BIOS

The BIOS Setup utility is featured by American Megatrends Inc to configure the system settings stored in the system's BIOS ROM. The BIOS is activated once the computer powers on. When the computer is off, the battery on the main board supplies power to BIOS RAM.

To enter the BIOS Setup utility, keep hitting the "Delete" key upon powering on the computer.

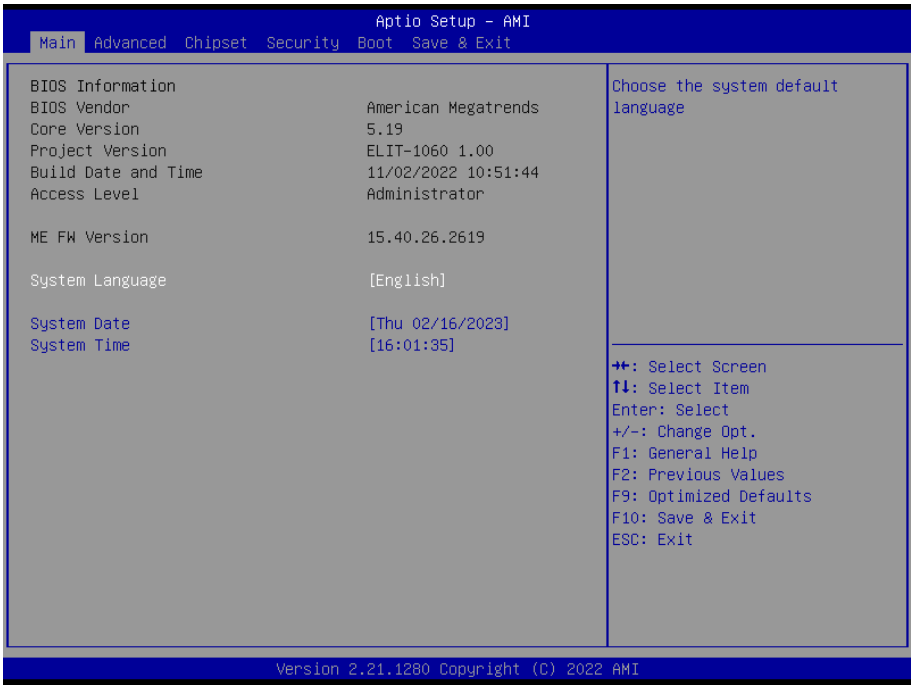

Menu	Description
Main	See 5.1. Main on page 38
Advanced	See 5.2. Advanced on page 39
Chipset	See 5.3. Chipset on page 56
Security	See 5.4. Security on page 56
Boot	See 5.5. Boot on page 63
Save & Exit	See 5.6. Save & Exit on page 64

Key Commands

The BIOS Setup utility relies on a keyboard to receive user's instructions. Hit the following keys to navigate within the utility and use the utility.

Keystroke	Function
← →	Moves left/right between the top menus.
↓ ↑	Moves up/down between highlight items.
Enter	Selects an highlighted item/field.
Esc	<ul style="list-style-type: none"> ▶ On the top menus: Use Esc to quit the utility without saving changes to CMOS. (The screen will prompt a message asking you to select OK or Cancel to exit discarding changes. ▶ On the submenus: Use Esc to quit current screen and return to the top menu.
Page Up / +	Increases current value to the next higher value or switches between available options.
Page Down / -	Decreases current value to the next lower value or switches between available options.
F1	Opens the Help of the BIOS Setup utility.
F2	Previous values
F9	Optimized defaults
F10	Exits the utility saving the changes that have been made. (The screen then prompts a message asking you to select OK or Cancel to exit saving changes.)

Note: Pay attention to the "WARNING" that shows at the left pane onscreen when making any change to the BIOS settings.

This BIOS Setup utility is updated from time to time to improve system performance and hence the screenshots hereinafter may not fully comply with what you actually have onscreen.

5.1. Main

The **Main** menu features the settings of **System Date** and **System Time** and displays some BIOS info.

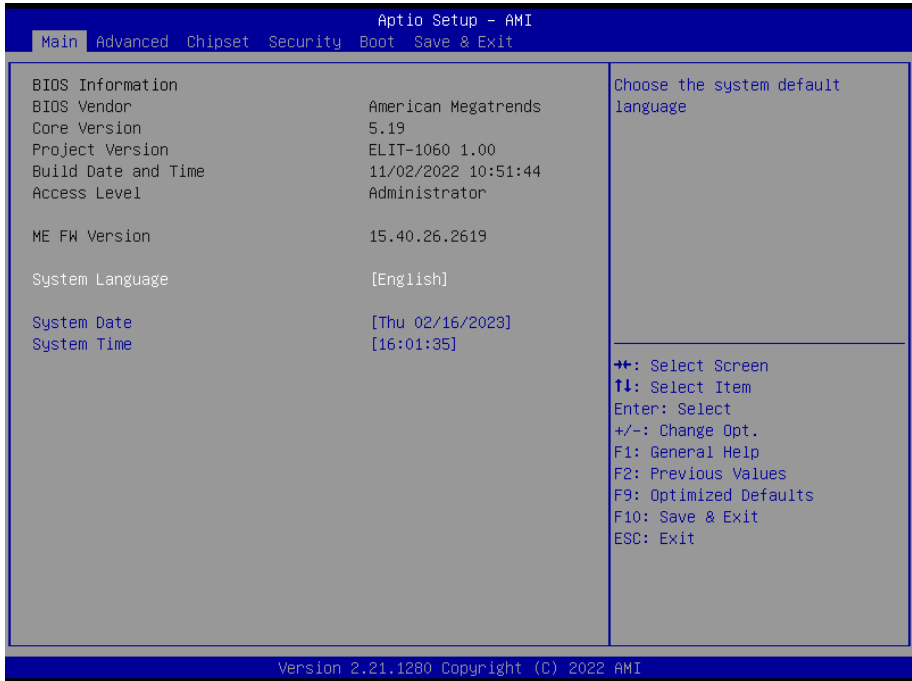

Setting	Description
BIOS Vendor	Delivers the computer's BIOS vendor.
Core Vision	Delivers the computer's BIOS version.
Project Version	Delivers the computer's Name and version.
Build Date and Time	Delivers the date and time when the BIOS Setup utility was made updated.
Access Level	Delivers access level
TXE FW Version	Delivers the TXE firmware version.
System Language	Sets system language.
System Date	Sets system date.
System Time	Sets system time.

5.2. Advanced

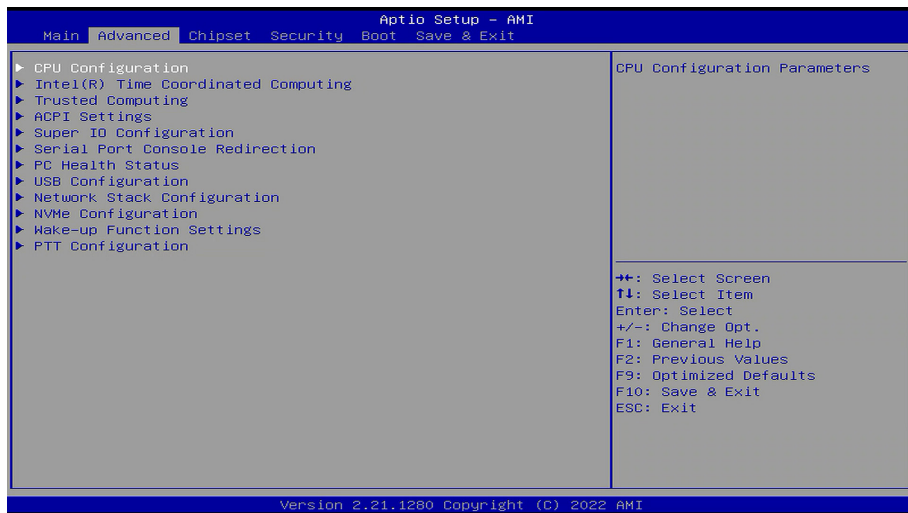

Setting	Description
CPU Configuration	See 5.2.1. CPU Configuration on page 40
Intel(R) Time Coordinated Computing	See 5.2.2. Intel(R) Time Coordinated Computing on page 42
Trusted Computing	See 5.2.3. Trusted Computing on page 43
ACPI Settings	See 5.2.4. ACPI Settings on page 44
Super IO Configuration	See 5.2.5. Super IO Configuration on page 45
Serial Port Console Redirection	See 5.2.6. Serial Port Console Redirection on page 47
PC Health Status	See 5.2.7. PC Health Status on page 49
USB Configuration	See 5.2.8. USB Configuration on page 50
Network Stack Configuration	See 5.2.9. Platform Trust Configuration on page 52
NVMe Configuration	See 5.2.10. NVMe Configuration on page 53
Wake-up Function Settings	See 5.2.11. Wake-up Function Settings on page 54
PTT Configuration	See 5.2.12. PTT Configuration on page 56

5.2.1. CPU Configuration

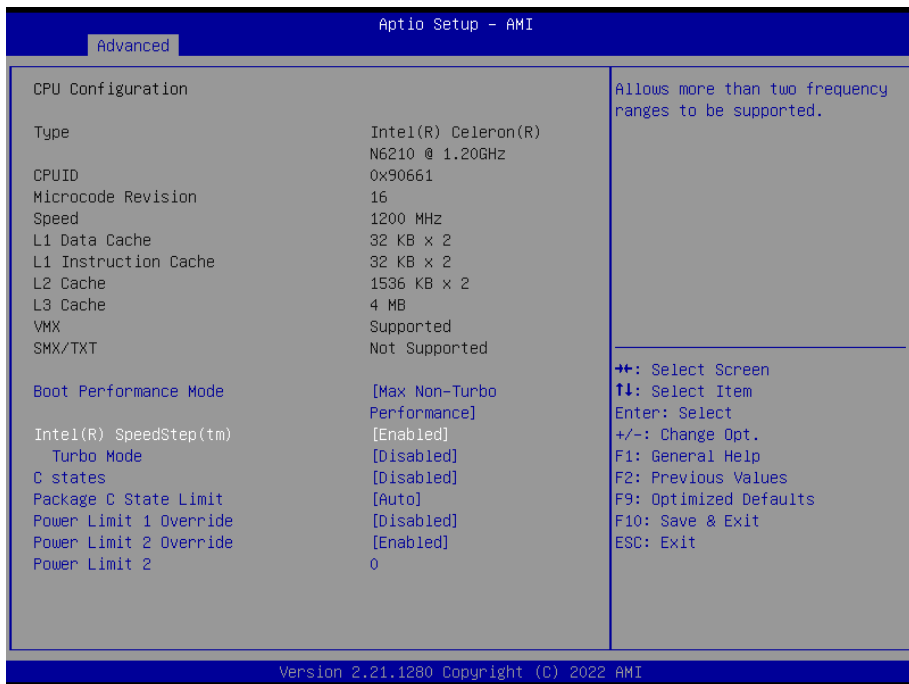

Setting	Description
Boot Performance Mode	Use this item to select the performance state that the BIOS will set starting from reset vector. The optional settings: [Max Battery]; [Max Non-Turbo Performance]; [Turbo Performance].
Intel(R) SpeedStep(tm)	[Enable](default) / [Disable] more than two frequency ranges to be supported.
Turbo Mode	Use this item to [Enable]/[Disable] processor Turbo Mode (requires EMTTM) enabled too) AUTO means enabled
C states	Use this item to [Enable]/[Disable] CPU Power Management. Allows CPU to go to C statens when it's not 100% utilized.
Enhanced C-states	Use this item to [Enable]/[Disable] C1E when enabled, CPU will switch to minimum speed when all cores enter C-state.
Package C State Limit	Use this item to Maximum Package C state Limit Setting CPU default: Leaves to factory default value. AUTO: Initializes package C state Limit. The optional settings: [C0/C1]; [C2]; [C3]; [C6]; [C7]; [C7S]; [C8]; [C9]; [C10]; [CPU Default]; [Auto]

Power Limit 1 Override	Use this item to [Enable]/[Disable] power Limit 1 override. If this option is disabled, BIOS will program the default values for power Limit 1 time Window.
Power Limit 2 Override	Use this item to [Enable]/[Disable] power Limit 2 override. If this option is disabled, BIOS will program the default values for Power Limit 2.
Power Limit 2	Use this item to power Limit 2 value in Milli watts. BIOS will round to the nearest 1/8W when programming. If the value is 0, BIOS will program this value as 1.25*TDP. For 12.50W, enter 12500. Processor applies control policies such that the package power does not exceed this limit.

5.2.2. Intel(R) Time Coordinated Computing

Select this submenu to view the main board’s hardware status. Select it to run a report of various info as depicted below:

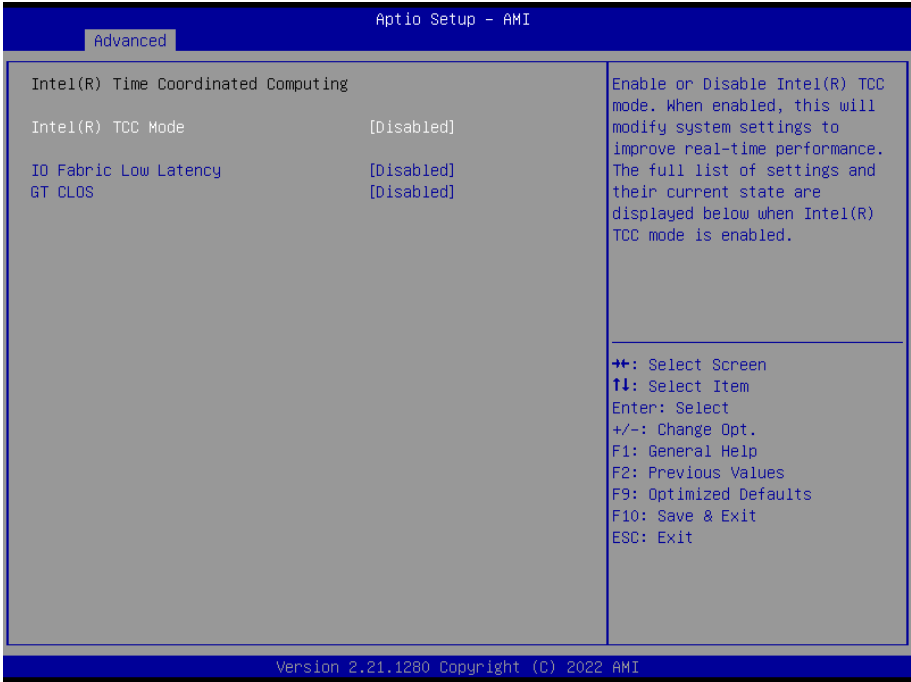

Setting	Description
Intel(R) TCC Mode	Use this item to [Enable]/[Disable] Intel(R) TCC mode. when enabled, this will modify system settings to improve real-time performance.
IO Fabric Low Latency	Use this item to [Enable]/[Disable] IO Fabric Low Latency. This will turn off some power management in the PCH IO fabrics. This option provides the most aggressive IO Fabric performance setting. S3 state is NOT supported
GT CLOS	Use this item to [Enable]/[Disable] Graphics Technology(GT) Class of Service. Enable will reduce Gfx LLC allocation to minimize impact of Gfx workload on LLC.

5.2.3. Trusted Computing



Setting	Description
Security Device Support	Use this item to [Enable]/[Disable] BIOS support for security device. O.S. will not show Security Device. TCG EFI protocol and INT1A interface will not be available.
SHA-1 PCR Bank	Use this item to [Enable]/[Disable] SHA-1 PCR Bank.
SHA256 PCR Bank	Use this item to [Enable]/[Disable] SHA256 PCR Bank.
SHA384 PCR Bank	Use this item to [Enable]/[Disable] SHA384 PCR Bank.
Pending Operation	Use this item to schedule an operation for the security device. NOTE: Your computer will reboot during restart in order to change state of security device

5.2.4. ACPI Settings



Setting	Description
ACPI Sleep State	Use this item to select the highest ACPI sleep state the system will enter when the SUSPEND button is pressed. ► The optional settings: [Suspend Disabled]; [S3 (Suspend to RAM)].

5.2.5. Super IO Configuration

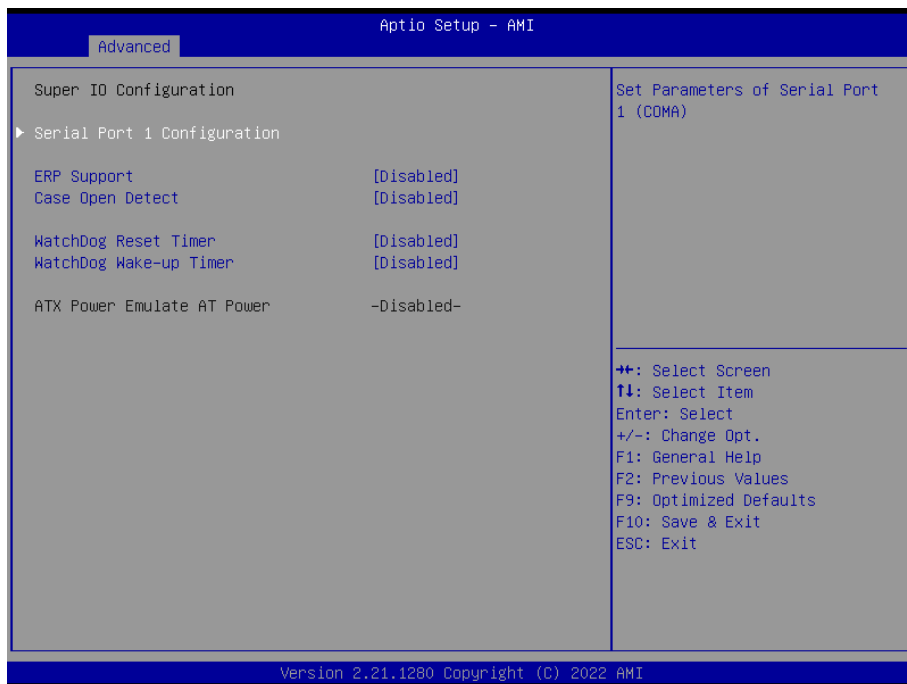

Setting	Description
Serial Port 1 Configuration	<p>Use this item to set parameters of Serial Port 1 (COMA). Press [Enter] to make settings for the following items:</p> <ul style="list-style-type: none"> ▶ Serial Port: The optional settings: [Enabled]/[Disabled]. ▶ Change Settings: Use this item to select an optimal setting for Super IO Device. The optional settings: [Auto]; [IO=3F8h; IRQ=4;]; [IO=2F8h; IRQ=3;]; [IO=3E8h; IRQ=4;]; [IO=2E8h; IRQ=3;]. ▶ Transmission Mode Select: The optional settings: [RS422]; [RS232]; [RS485]. ▶ Mode Speed Select: Use this item to select RS232/RS422/RS485 Speed. The optional settings: [RS232/RS422/RS485=250kbps]; [RS232=1Mbps, RS422/RS485=10Mbps].
ERP Support	<p>This item is Energy-Related Products function. The optional settings: [Disabled](default); [Enabled]</p>

WatchDog Reset Timer	Use this item to enable or disable WDT reset function. The optional settings: [Disabled] ; [Enabled] .
WatchDog Wake-up Timer	This item support WDT wake-up. The optional settings: [Disabled] ; [Enabled] .

5.2.6 Serial Port Console Redirection



Setting	Description
Console Redirection	<p>Use this item to enable or disable Console Redirection. The optional settings: [Disabled]; [Enabled].</p> <p>When set as [Enabled], user can make further settings in the following items:</p>

<p>Console Redirection EMS</p>	<p>The optional settings: [Disabled]; [Enabled]</p> <p>When set as [Enabled], the following sub-items shall appear: Console Redirection Settings</p> <p>Out-of-Band Mgmt Port The default setting is: [COM1].</p> <ul style="list-style-type: none">▶ Terminal Type EMS The optional settings: [VT100]; [VT100+]; [VT-UTF8]; [ANSI].▶ Bits per second EMS The optional settings: [9600]; [19200]; [57600]; [115200].▶ Flow Control EMS The optional settings: [None]; [Hardware RTS/CTS]; [Software Xon/Xoff].▶ Data Bits The default setting is: [8]▶ Parity The default setting is: [None].▶ Stop Bits The default setting is: [1].
---	---

5.2.7. PC Health Status

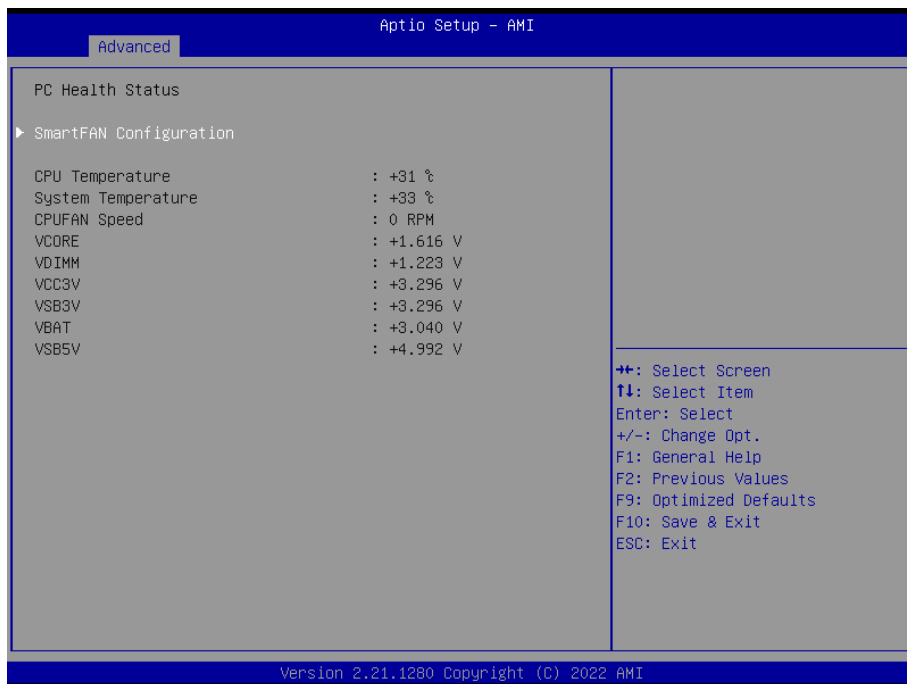

Setting	Description
SmartFAN Configuration	<p>Press [Enter] to view current hardware health status, make further settings in 'SmartFAN Configuration'.</p> <ul style="list-style-type: none"> ▶ CPUFAN Smart Mode: The optional settings: [Disabled]; [Enabled](default). ▶ CPUFAN Full-Speed Temperature Set CPUFAN full speed temperature. Fan will run at full speed when above this pre-set temperature. ▶ CPUFAN Full-Speed Duty Set CPUFAN full-speed duty. Fan will run at full speed when above this pre-set duty. ▶ CPUFAN Idle-Speed Temperature Set CPUFAN idle speed temperature. Fan will run at idle speed when below this pre-set temperature. ▶ CPUFAN Idle-Speed Duty Set CPUFAN idle speed duty. Fan will run at idle speed when below this pre-set duty.

5.2.8. USB Configuration

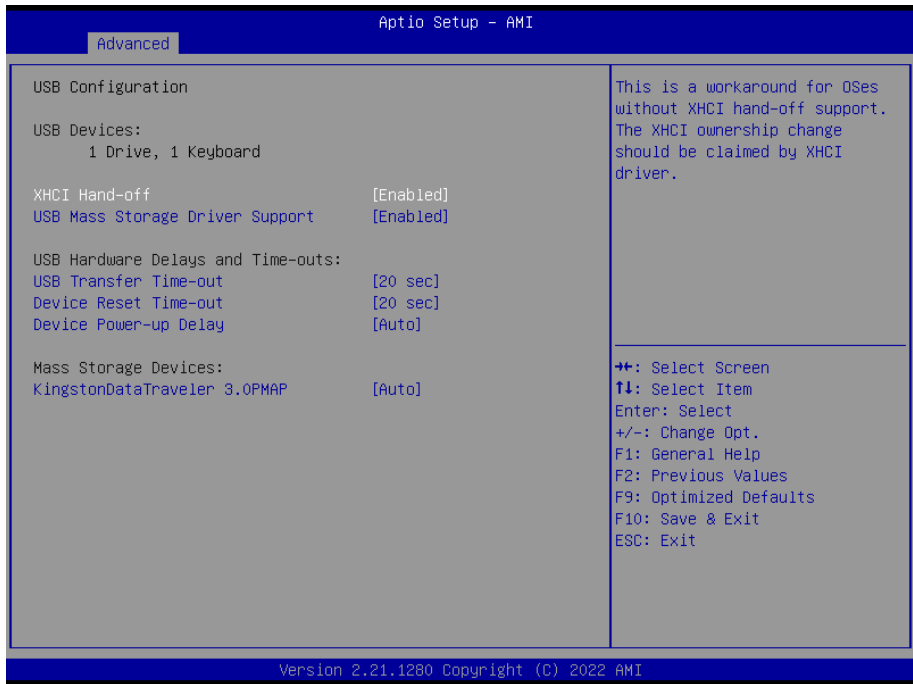

Setting	Description
XHCI Hand-off	This is a workaround for OSeS without XHCI hand-off support. The XHCI ownership change should be claimed by XHCI driver. ▶ Options available are: Enabled (default) / Disabled .
USB Mass Storage Driver Support	Enables/disables USB Mass Storage Driver Support. ▶ Options available are: Enabled (default) / Disabled .
USB hardware delay and time-out	
USB transfer time-out	Use this item to set the time-out value for control, bulk, and interrupt transfers. ▶ Options: 1 sec, 5 sec, 10 sec, 20 sec (default)
Device reset time-out	Use this item to set USB mass storage device start unit command time-out. ▶ Options available are: 10 sec, 20 sec (default), 30 sec, 40 sec

Device power-up delay

Use this item to set maximum time the device will take before it properly reports itself to the host controller. 'Auto' uses default value: for a root port it is 100 ms, for a hub port the delay is taken from hub descriptor.

► Options available are:

Auto: Default

Manual: Select **Manual** you can set value for the following sub-item: 'Device Power-up delay in seconds', the delay range in from 1 to 40 seconds, in one second increments.

5.2.9. Network Stack Configuration



Setting	Description
Network Stack	[Enable] / [Disable] (default).

5.2.10. NVMe Configuration



Access this submenu to view the NVMe controller and driver information.

5.2.11. Wake-up Function Settings

Aptio Setup - AMI

Advanced

Wake-up System with Fixed Time	[Disabled]	Enable or disable system wake-up by RTC alarm. When this function is enabled, system will wake on the time(hr::min::sec) specified.
Wake-up System with Dynamic Time	[Disabled]	
USB Power Gating S4-S5	[Enabled]	
PCIe Wake-up from S3-S5	[Enabled]	

++: Select Screen
 ↑↓: Select Item
 Enter: Select
 +/-: Change Opt.
 F1: General Help
 F2: Previous Values
 F9: Optimized Defaults
 F10: Save & Exit
 ESC: Exit

Version 2.21.1280 Copyright (C) 2022 AMI

Setting	Description
Onboard Audio	[Enable] (default) / [Disable] the onboard audio device.
Onboard LAN1/2	[Enable] (default) / [Disable] the onboard LAN1/2 device.
DVMT Pre-Allocated	Select DVMT 5.0 pre-allocated (fixed) graphics memory size used by the internal graphics device. ► Options: [32M] , [64M] (default), [128M] , [256M] and [512M]
ERP Lowest Power State Mode	[Enable] / [Disable] (default) the ERP lowest power state mode. When this item is set to Enabled, the following functions will become unavailable: RTC Wake, PME event wake and wake on LAN.
Restore AC Power Loss	Select AC power state when power is re-applies after a power failure. ► Options: [Power Off] (default), [Power On] and [Last State]
I2C1 address	Input I2C1 slave address value 0~255.
I2C1 clock	Choose I2C1 connection speed. ► Options: [100 MHz] , [400 MHz] (default) and [3200 MHz] .

Use internal UART to output debug	<ul style="list-style-type: none"> ▶ Enabled: Use internal UART to output debug message in OS; ▶ Disabled (default): No use internal UART to output debug message in OS.
SCC eMMC Support	<p>SCC eMMC support mode</p> <ul style="list-style-type: none"> ▶ Options: [ACPI mode](default), [PCI mode] and [Disabled]
SCC eMMC on legacy	<p>[Enable](default) or [Disable] SCC eMMC support on legacy eMMC</p>
LPSS with GPIO Devices support	<p>[Enable] (default) or GPIO ACPI device support. Disable it will disable all LPSS devices.</p>
LPSS DMA #1/#2	<p>Enable/disable LPSS DMA #1/#2 support</p> <ul style="list-style-type: none"> ▶ Options: [ACPI mode](default), [PCI mode] and [Disable]
LPSS I2C #1	<p>Enable/disable LPSS I2C # support</p> <ul style="list-style-type: none"> ▶ Options: [ACPI mode](default), [PCI mode] and [Disable]
LPSS HSUART #1/#2	<p>Enable/disable LPSS HSUART #1/#2 support</p> <ul style="list-style-type: none"> ▶ Options: [ACPI mode](default), [PCI mode] and [Disable]

5.2.12. PTT Configuration



Setting	Description
TPM Device Selection	► Options: [PTT] or [dTPM] . PTT-Enables PTT IN SkuMgr dTPM- Disables PTT in SkuMgr

5.3. Chipset



Submenu	Description
System Agent (SA) Configuration	See 5.3.1. System Agent (SA) Configuration on page 58
PCH-IO Configuration	See 5.3.2. PCH-IO Configuration on page 59

5.3.1. System Agent (SA) Configuration

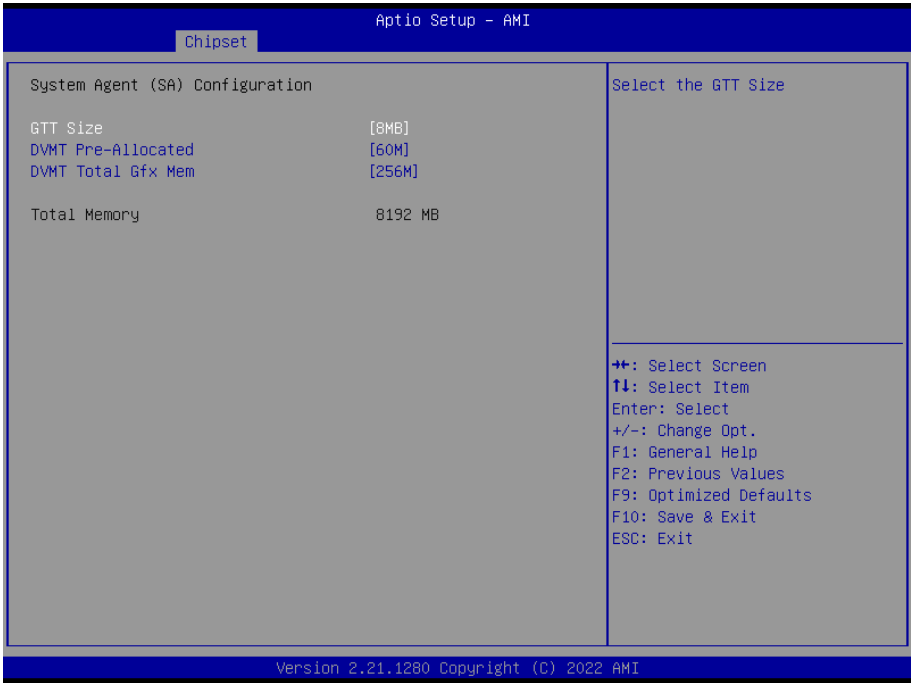

Setting	Description
GTT Size	Enable / Disable (default) TXE HMRFP0. Use this item to select the GTT Size. The optional settings: [2MB]; [4MB]; [8MB].
DVMT Pre-Allocated	Use this item to select DVMT 5.0 Pre-Allocated (Fixed) Graphics Memory size used by the Internal Graphics Device. The optional settings: [0M]; [4M]; [8M]; [12M]; [16M]; [20M]; [24M]; [28M]; [32M]; [36M]; [40M]; [44M]; [48M]; [52M]; [56M]; [60M]; [64M]; [96M]; [128M]; [160M]
DVMT Total Gfx Mem	Use this item to select DVMT 5.0 Total Graphic Memory size used by the Internal Graphics Device. The optional settings: [128M]; [256M]; [MAX].

5.3.2. PCH-IO Configuration

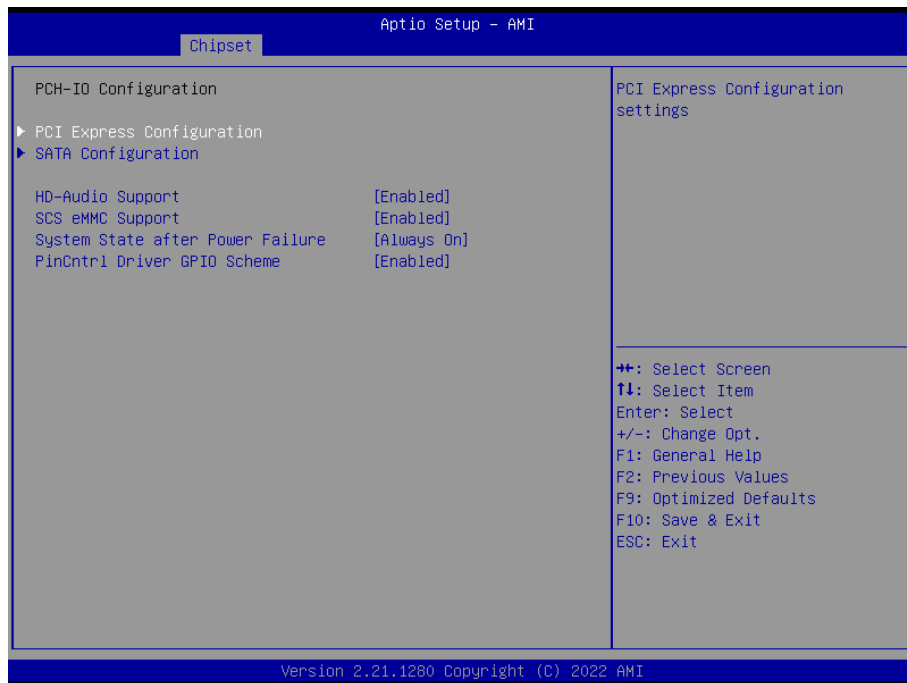

Setting	Description
PCI Express Configuration	Press [Enter] to make settings for the following sub-items: Peer Memory Write Enable Use this item to enable or disable peer memory write. The optional settings: [Disabled] ; [Enabled] .
SATA Configuration	
SATA Controller	Use this item to enable or disable SATA device. The optional settings: [Disabled] ; [Enabled] . When set as [Enabled] , the following sub-items shall appear:
SATA Mode Selection	This item determines how SATA controller(s) operate. The optional settings: [AHCI] .
SATA Port	The optional settings: [Disabled] ; [Enabled] .
Hot Plug	Use this item to designates this port as Hot Pluggable The optional settings: [Disabled] ; [Enabled]
M.2	The optional settings: [Disabled] ; [Enabled] .

HD-Audio Support	The optional settings: [Disabled] ; [Enabled] .
SCS eMMC Support	The optional settings: [Disabled] ; [Enabled] .
System State after Power Failure	Use this item to specify what state to go to when power is re-applied after a power failure. The optional settings: [Always On] ; [Always Off] ; [Former State] .
PinCntrl Driver GPIO Scheme	Use this item to enable/disable PinCntrl Driver GPIO Scheme The optional settings: [Disabled] ; [Enabled] .

5.4. Security



Setting	Description
Administrator/ User Password	<p>If ONLY the Administrator's password is set, then this only limits access to Setup and is only asked for when entering Setup.</p> <p>If ONLY the User's password is set, then this is a power on password and must be entered to boot or enter Setup. In Setup the User will have Administrator rights.</p> <p>The password must be less than 3 characters and no more than 20 characters.</p> <p>To set up an administrator/user password:</p> <ol style="list-style-type: none"> 1. Select Administrator/User Password. 2. An Create New Password dialog then pops up onscreen. 3. Enter your desired password that is no less than 3 characters and no more than 20 characters. 4. Hit [Enter] key to submit.

Secure Boot menu	<p>Secure Boot</p> <p>Press [Enter] to make customized secure settings:</p> <p>Secure Boot Mode</p> <ul style="list-style-type: none">▶ Restore Factory Keys Use this item to force system to User Mode, to install factory default Secure Boot key databases.▶ Reset To Setup Mode Use this item to delete all Secure Boot key databases from NVRAM.▶ Key Management This item enables expert users to modify Secure Boot Policy.
-------------------------	---

5.5. Boot

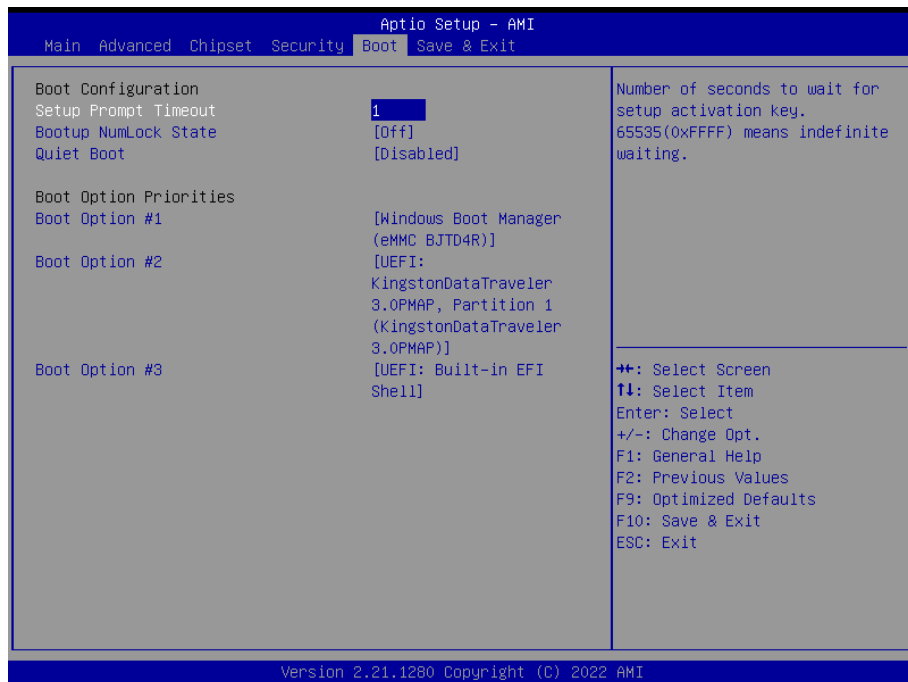

Setting	Description
Setup Prompt Timeout	Use this item to set number of seconds to wait for setup activation key. 65535 (0xFFFF) means indefinite waiting.
Bootup NumLock State	Use this item to select the keyboard NumLock state. ▶ The optional settings: [On] ; [Off] .
Quiet Boot	▶ The optional settings: [Disabled] ; [Enabled] .
Boot Option Priorities	
Boot Option #1	Use this item to set the system boot order. The optional settings: [Windows Boot Manager (MMC – BJTD4R)] ; [MMC - BJTD4R] ; [UEI: Built-in EFI Shell] ; [Disabled] . Hard Drive BBS Priorities Use this item to set the order of the legacy devices in this group. Press [Enter] to make customized secure settings: Boot Option#1 Use this item to set the system boot order. ▶ The optional settings: [UEFI: Built-in EFI Shell] ; [Disabled] .

5.6. Save & Exit



Setting	Description
Save Changes and Reset	Saves the changes and quits the BIOS Setup utility.
Discard Changes and Exit	Quits the BIOS Setup utility without saving the change(s).
Restore Defaults	Use this item to restore /load default values for all the setup options.. ▶ This is a command to launch an action from the BIOS Setup utility.
Save as User Defaults	Use this item to save the changes done so far as user defaults.
Restore User Defaults	Use this item to restore defaults to all the setup options.
Boot Override	Allows you to override the boot priorities and boot from a specific drive.
UEFI: Built-in EFI Shell	Use this item to save or reset configuration of UEFI.

